



Contrafechos para cremonas de correr

Funcionalidade & design discreto com resistência à corrosão

Novos Contrafechos para cremonas de correr

Funcionalidade & Design discreto com resistência à corrosão

Os novos contrafechos para fechamento multiponto aplicados em portas e janelas de correr da Roto Fermax são fabricados em **Aço Inox SS304** e poliamida, sendo ideais para obras localizadas em regiões litorâneas.



- Design discreto;
- Acabamentos base poliamida: preto e branco;
- Compatíveis com perfis em Alumínio e PVC;
- Aço Inox SS304: resistente à corrosão;
- Fácil instalação;
- Resistência mecânica;
- Compatível com cremonas Roto agulha de 7mm e 17mm;
- Ideal para regiões litorâneas.

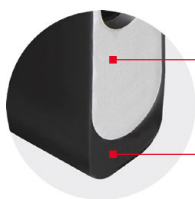

Inox SS304

Poliamida

Uma nova opção

Os contrafechos em Inox possuem as mesmas aplicações dos contrafechos fabricados em Zamak. Confira na tabela abaixo a equivalência entre eles:

Tabela de equivalência

Zamak	Inox / Preto	Inox / Branco
617133	2040175	2040267
629551	2040268	2040294
617133T-U 828192 629560	2040295	2040296
61713300-ALCOLU	2040297	2040298
61713300-SUPERIA	2040299	2040300
61713300-ALUSHOW	2040301	2040302
629554 629555 629518 629516	2040303	2040304



2040175 | 2040267

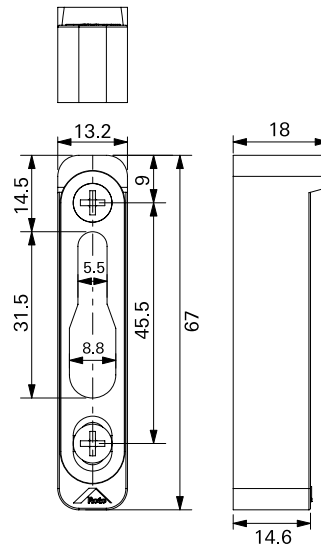
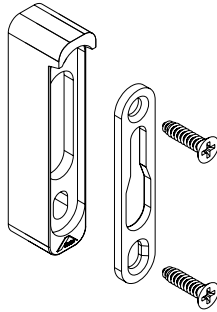

2040268 | 2040294

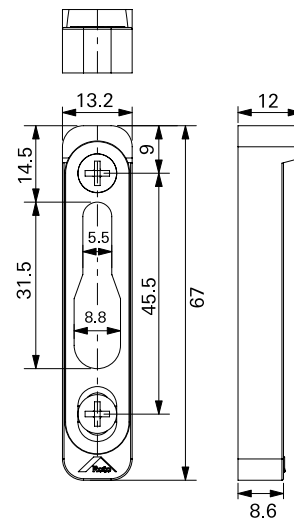
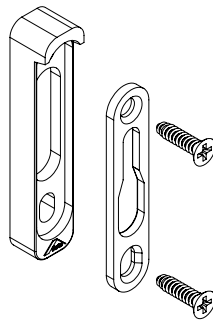

2040295 | 2040296

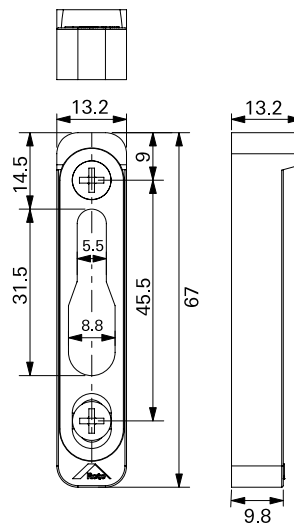
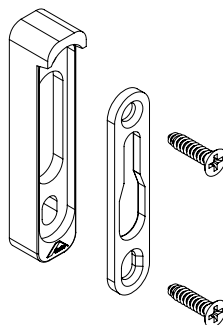

2040297 | 2040298

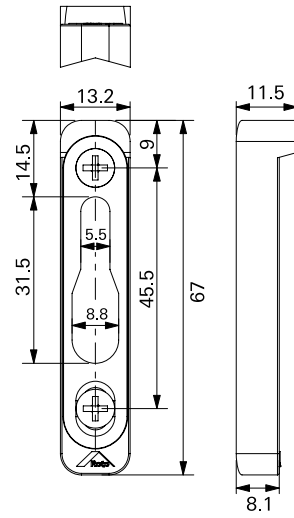
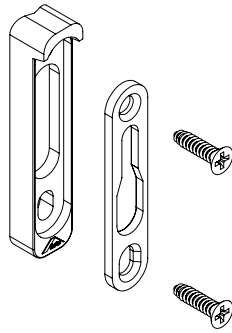

2040299 | 2040300

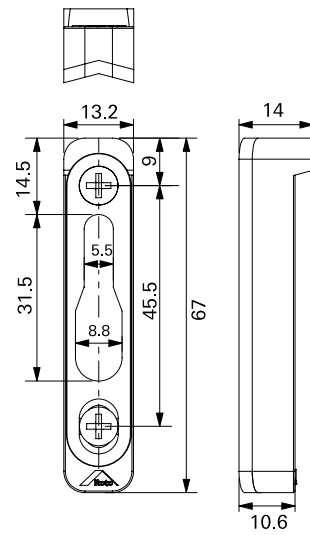
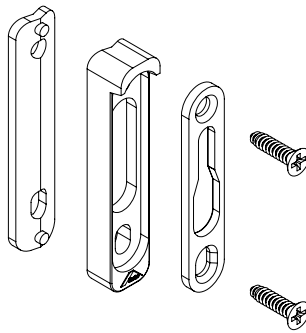

2040301 | 2040302

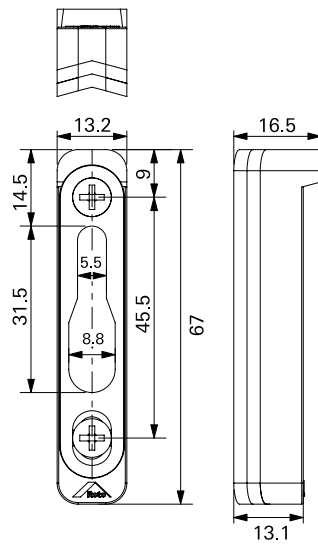
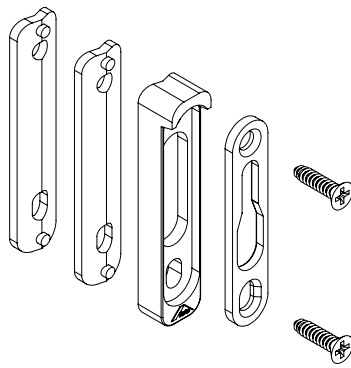

2040303 | 2040304

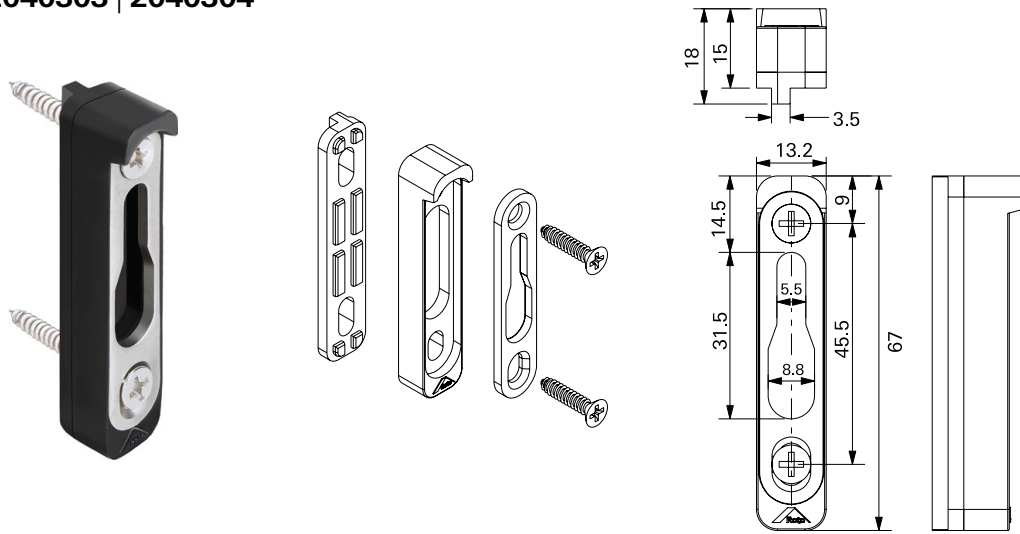

Usinagem e posicionamento

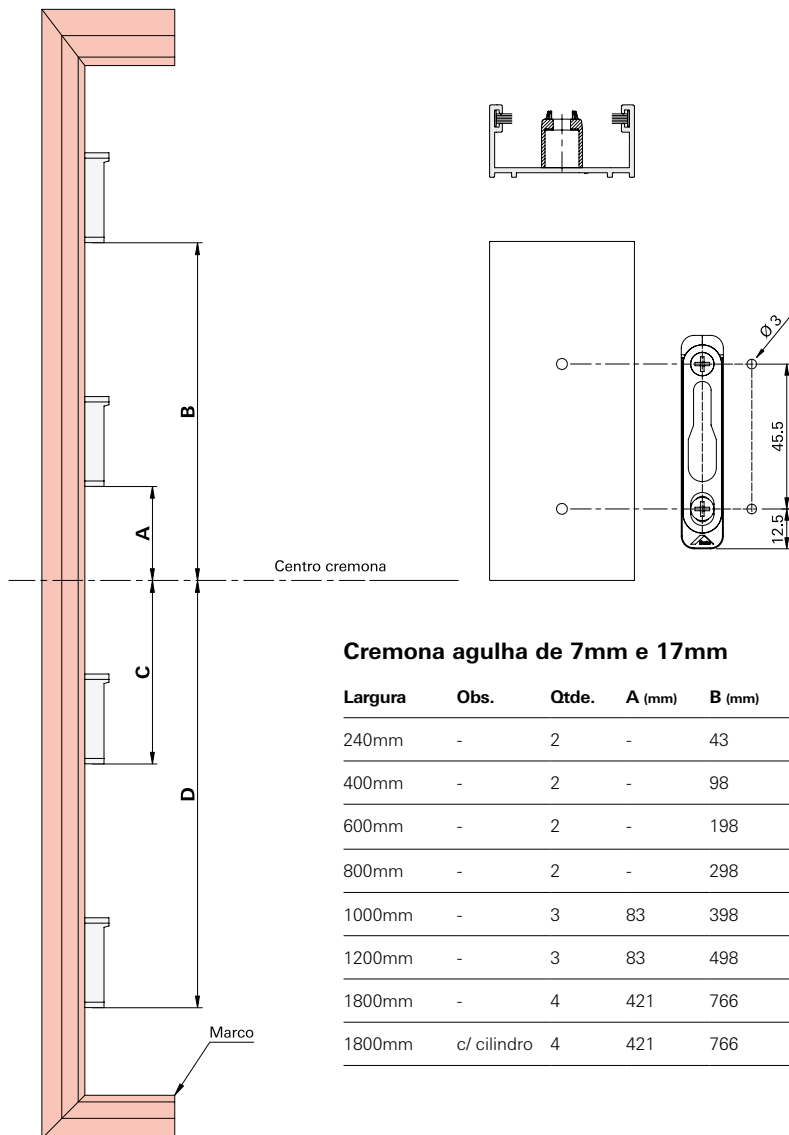

Cremona agulha de 7mm e 17mm

Largura	Obs.	Qtde.	A (mm)	B (mm)	C (mm)	D (mm)
240mm	-	2	-	43	-	117
400mm	-	2	-	98	-	172
600mm	-	2	-	198	-	272
800mm	-	2	-	298	-	372
1000mm	-	3	83	398	-	472
1200mm	-	3	83	498	-	572
1800mm	-	4	421	766	475	819
1800mm	c/ cilindro	4	421	766	475	819



www.rotofermax.com.br

