

Novembro/2021

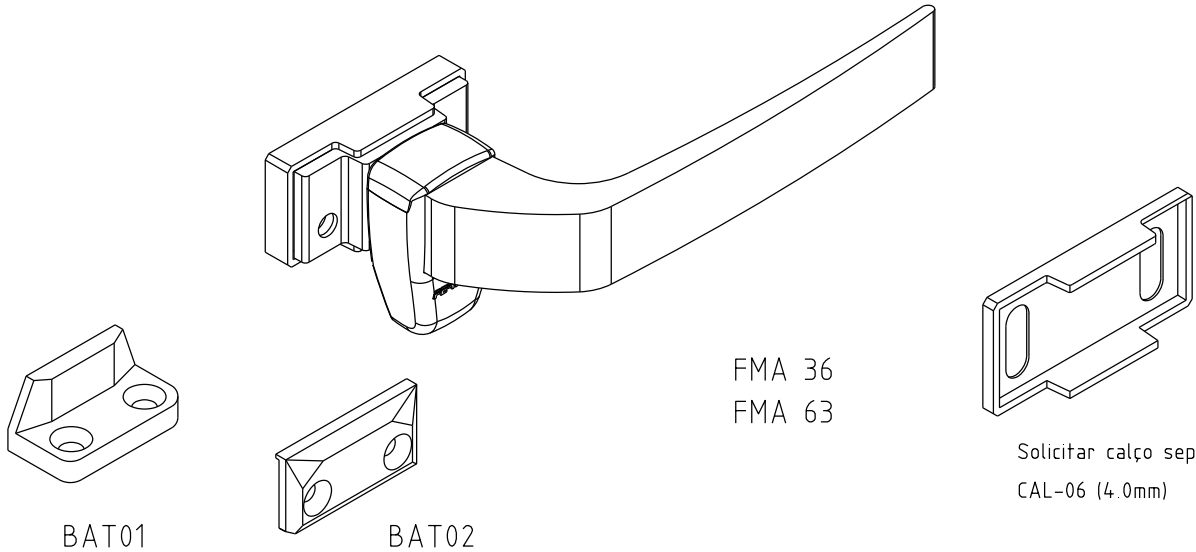

FMA 36
 FMA 63

Solicitar calço separadamente
 CAL-06 (4.0mm)

BAT01

BAT02

Solicitar contrafechos separadamente p/ FMA36

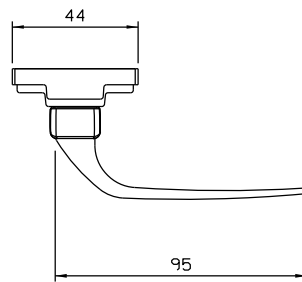
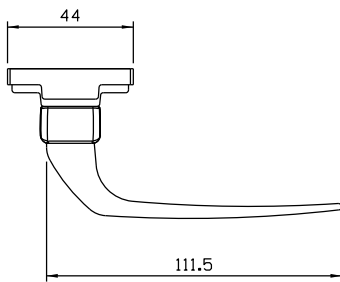
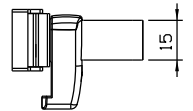
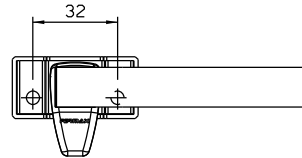
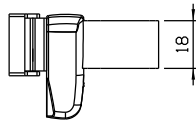
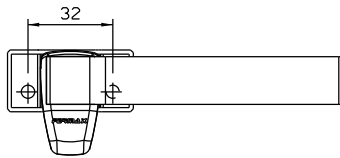

Vista FMA 36 - sem escala

Vista FMA 63 - sem escala

Contrafechos - escala 1:2

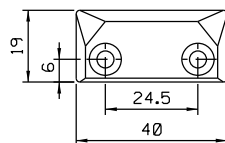
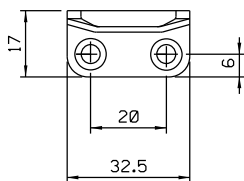
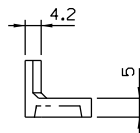
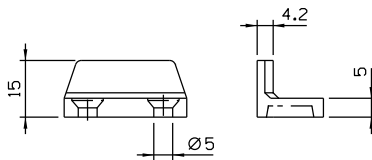

BAT01

BAT02

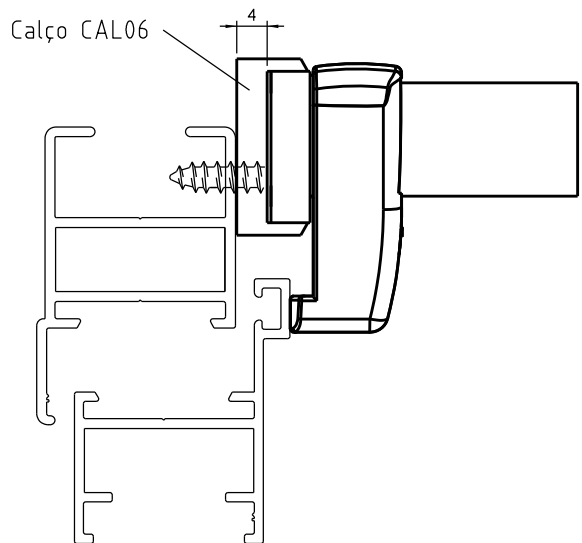

Medidas em milímetros

Composição
 Base/cabo duralumínio
 Contrafecho/arremates em nylon
 Parafusos inox

Instalação - escala 1:1