

Novembro/2010

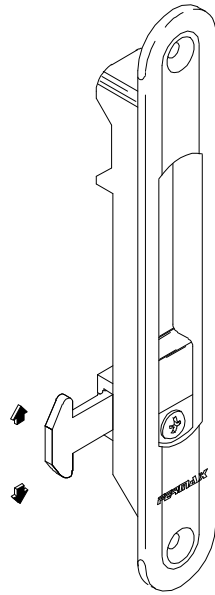

FEC 46 c/ trava automática
FEC 47 c/ trava manual

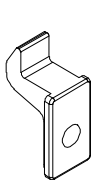

CFE 22

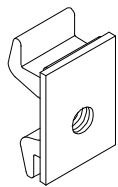

CFE 23

Contra-fecho lateral
Escala 1:1

Contra-fecho central
Escala 1:1

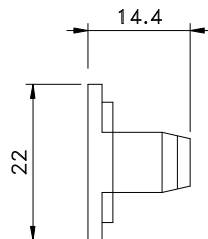
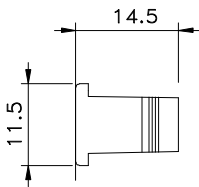
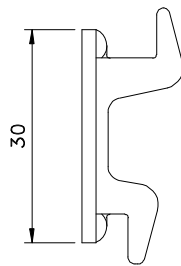
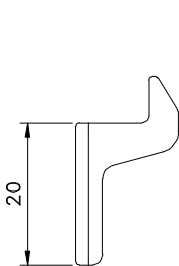

Medidas em milímetros

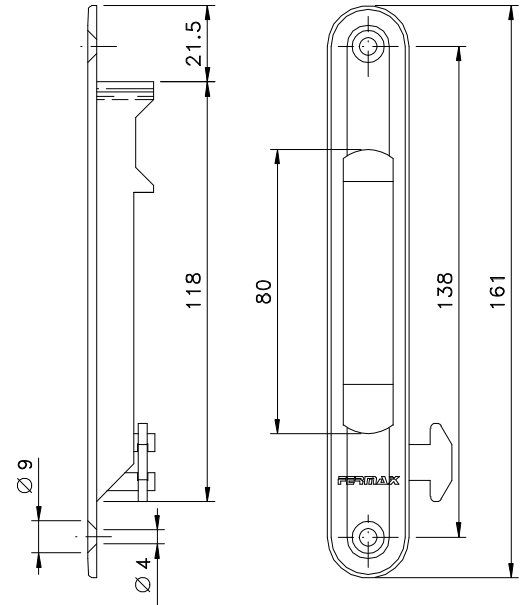
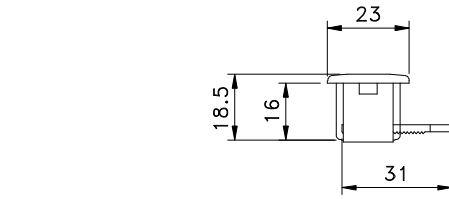

Vistas - escala 1:2

contra-fecho lateral

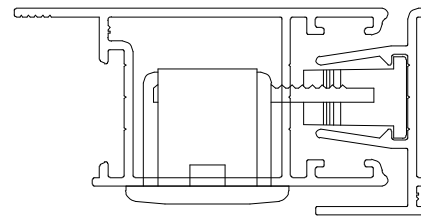

contra-fecho central

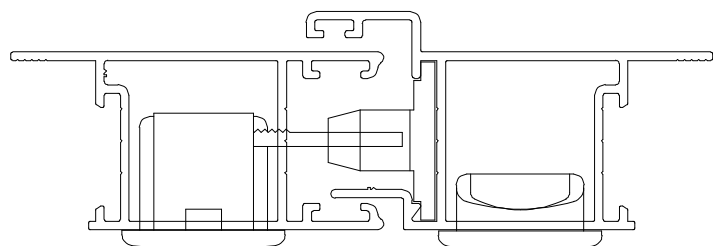

Composição

Base poliamida 6.6
Mecanismo alumínio
Parafuso M5 x 8 inox

Instalação - escala 1:1