

ROLDANA SIMPLES C/ROL.E REG. - ROL71N

Resistência à corrosão: rolamento 90h. teste Salt Spray

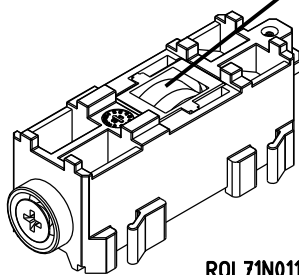

ROL71N011
40 kg p/folha

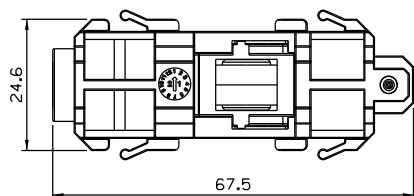
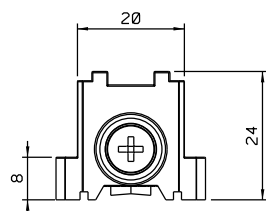
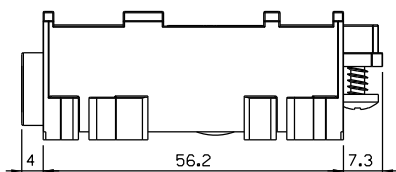

Vistas - escala 1:1

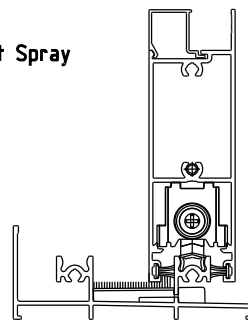

SUBLIME 3.5

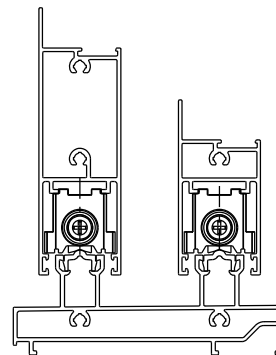

NOVA GOLD

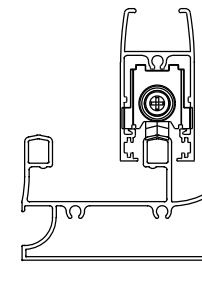

RENOIR 3.3

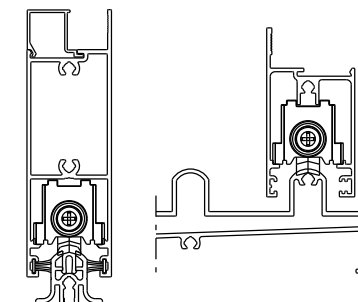

IMPERIAL 3.5 (porta/janela)

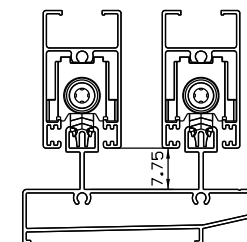

SLIM EX-32

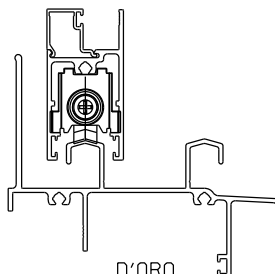

D'ORO

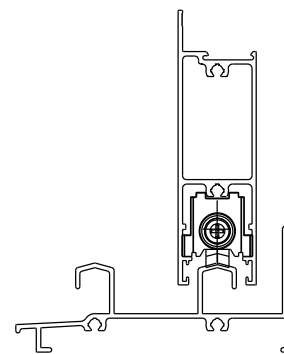

AGLO 3.2

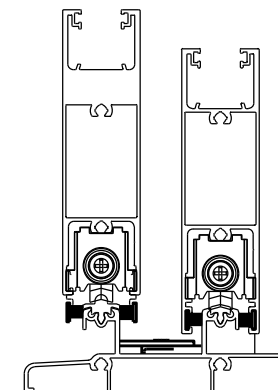

CHROMA

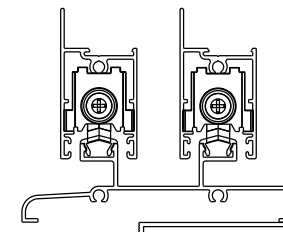

PRIME 32

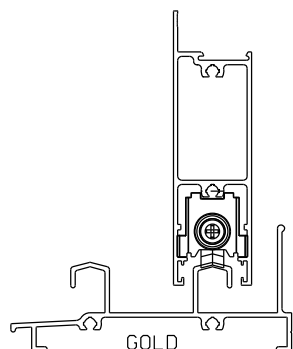

GOLD

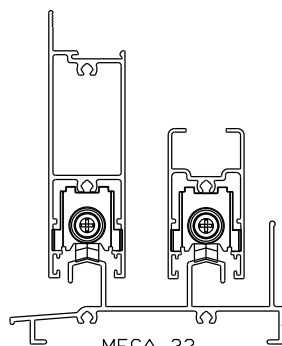

MEGA 32

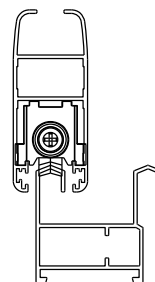

TERA_AURA40

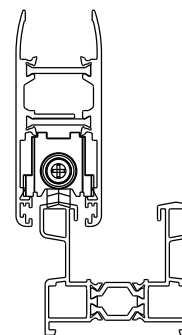

TERA_AURA55C

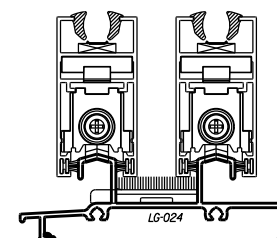

MAGNAPLUS

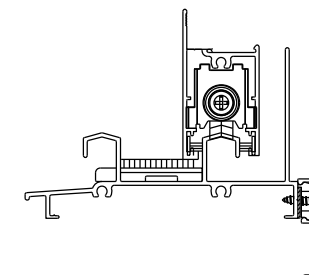

PERFILEVE 32

Composição

- Cavelete/suporte da roda nylon
- Rolamento aço/nylon
- Parafusos inox
- Pack: 02 pçs

Instalação - escala 1:2