

Resistência à corrosão: rolamento 90h teste Salt Spray

ROL40N011
80 kg p/folha

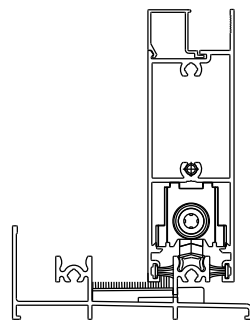

SUBLIME 3.5

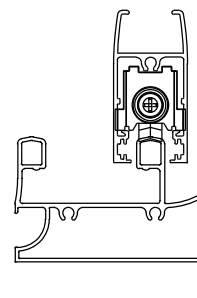

RENOIR 3.3

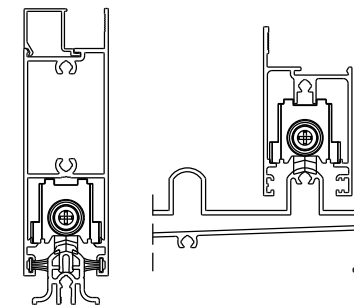

IMPERIAL 3.5 (porta/janela)

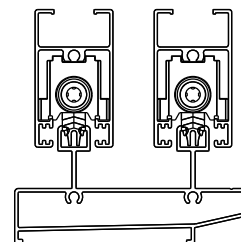
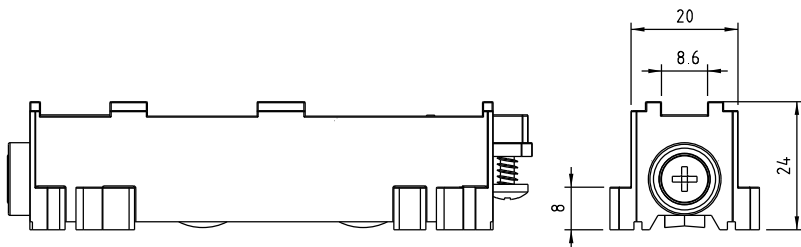

SLIM EX-32

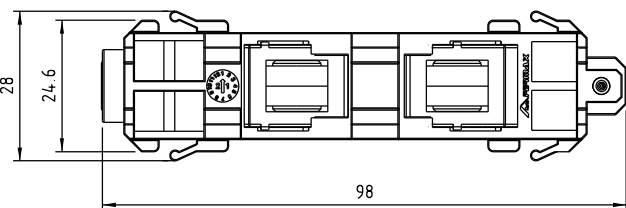

Vistas - escala 1:1

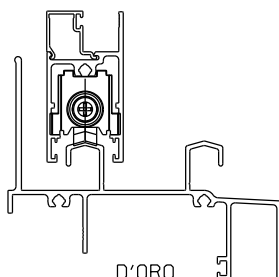

D'ORO

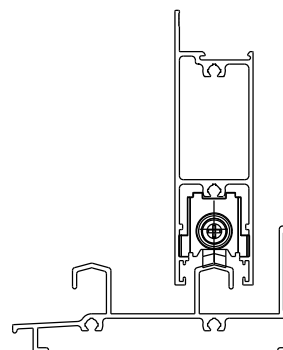

AGLO 3.2

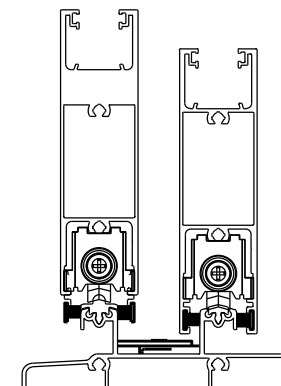

CHROMA

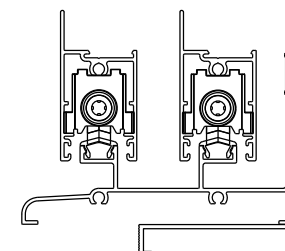

PRIME 32

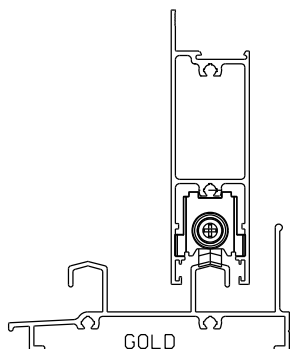

GOLD

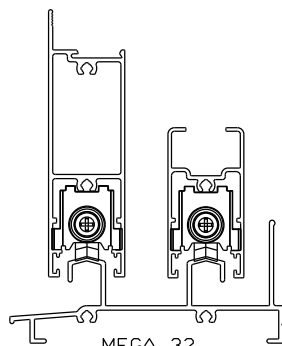

MEGA 32

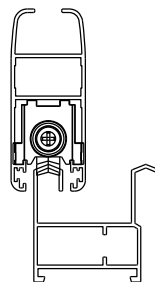

TERA_AURA40

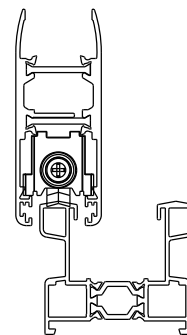

TERA_AURA55C

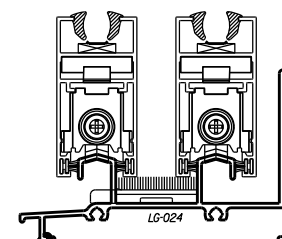

MAGNAPLUS

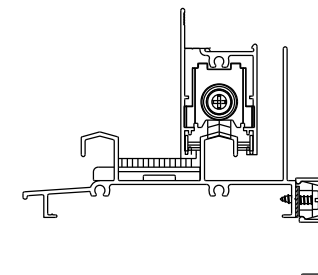

PERFILEVEVE 32

Composição
 Cavalete/suporte da roda nylon
 Rolamento aço/nylon
 Parafusos inox
 Pack: 02 pcs

Instalação - escala 1:2