

- RECOMENDADO PARA FOLHAS DE ATÉ 80KG
- APLICÁVEL NO MONTANTE DA FOLHA
- QUANDO DO USO DE CREMONA APLICAR A BTD17 NA TRAVESSA INFERIOR

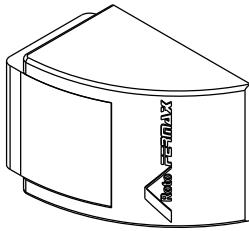

BTD17012 (PTO)
BTD17016 (BCO)

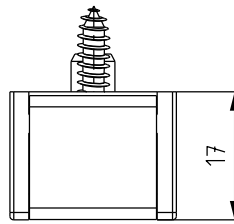
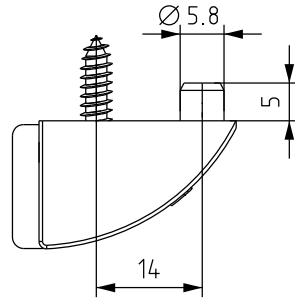
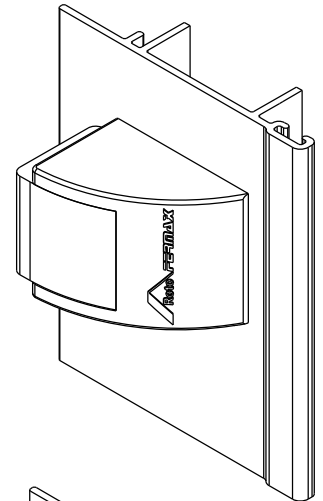
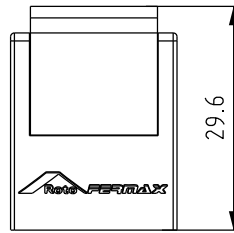

ESCALA 1:1

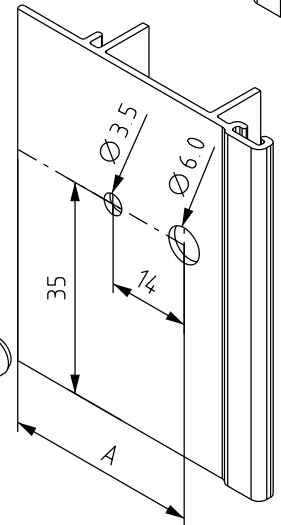

DETALHE DE USINAGEM
SEM ESCALA

COMPOSIÇÃO
BATEDEIRA POLIAMIDA
BATEDOR EPDM
PARAFUSO INOX
EMBALAGEM
10 PARAFUSOS
10 BATEDORES
10 BATEDEIRAS

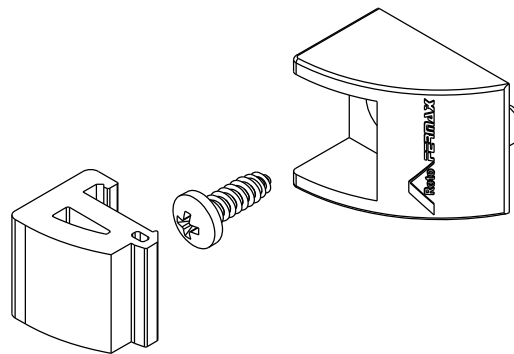

INSTRUÇÃO PARA COLOCAÇÃO DO BATEDOR

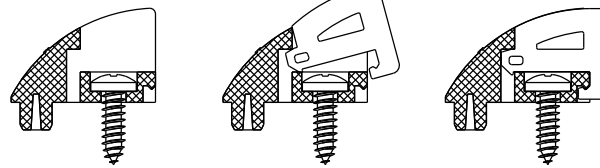

AUTEM 20EX

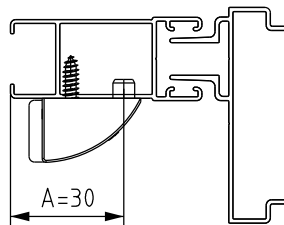

MASTER

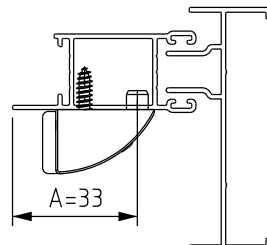

UNNION

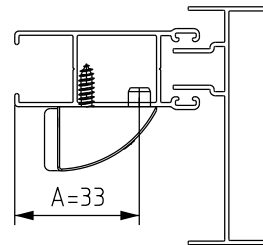

SP-20

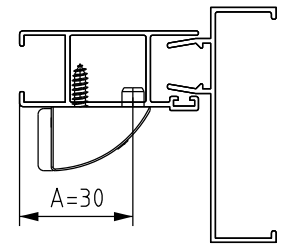

PRIME 2.0

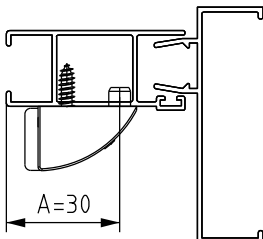

MEGA20

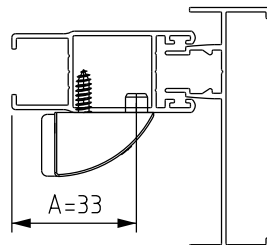

SMART 2.0

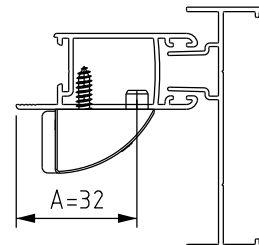

AGLO 2.0

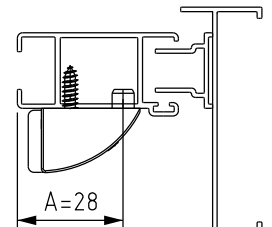

INSTALAÇÃO ESCALA 1:2