

FMA177 ARM01

FMA177 ARM02

FMA177

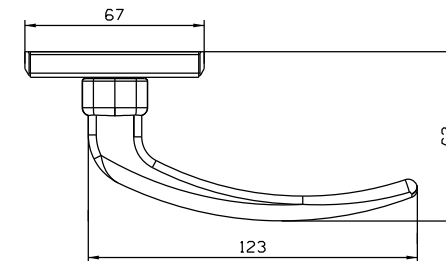
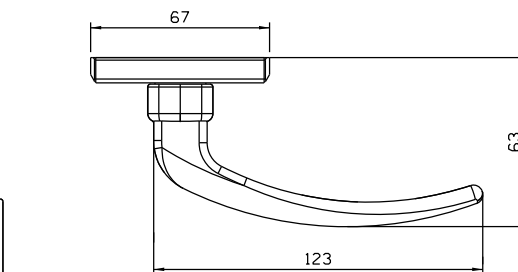
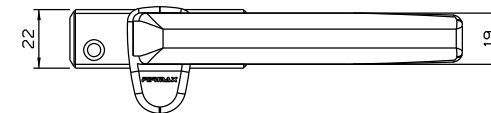
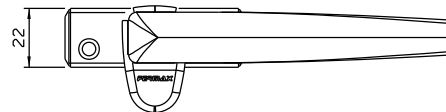
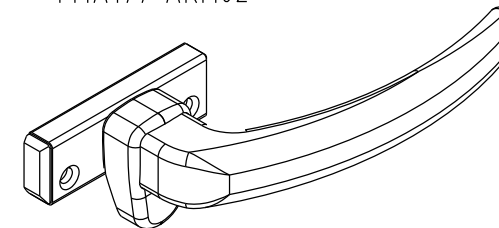
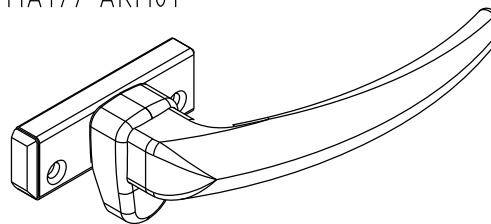
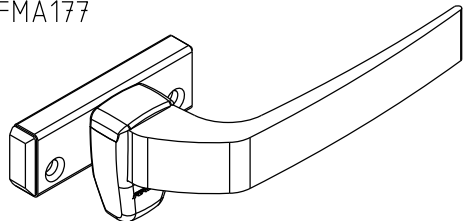

Setembro/2023

Medidas em milímetros

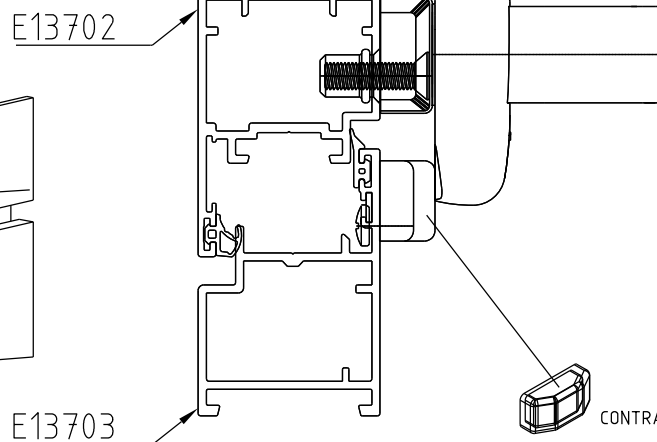
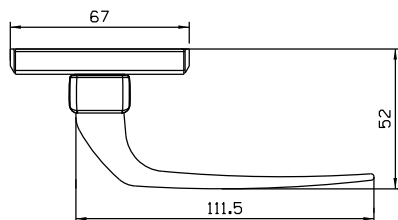

FMA177 ARM03

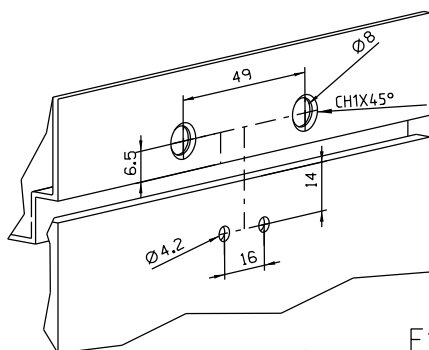
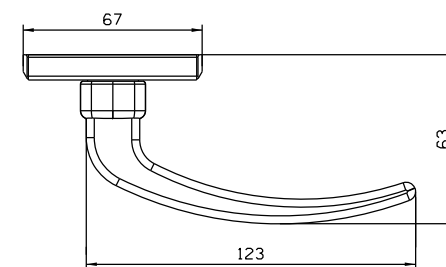
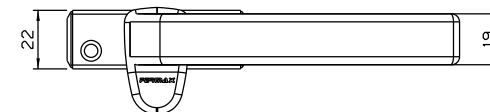
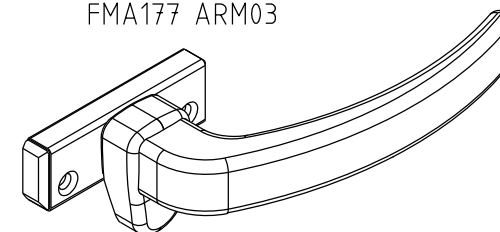

USINAGEM
Sem Escala

INSTALAÇÃO
Escala 1:1

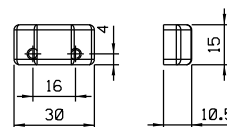

Escala 1:2

COMPOSIÇÃO

- Base e cabo alumínio
- Contrafecho, arremates e lingueta Poliamida 6.6
- Parafusos Aço Inox
- Rebite de repuxo Alumínio

VISTAS
Escala 1:2